

DELIXI

CDJ1



CDJ1



CDJ1

1

2

CDJ1

3

CDJ1

4

L1 L2 L3

U V W

5

U V W

6

CDJ1

7

8

9



380V 50H

12

90%

-3

3000

0.5G

AC-53b



CDJ1-S 75kW

	- 1 -
	- 2 -
	- 3 -
	- 4 -
	- 8 -
	- 9 -
	- 22 -
	- 25 -
	- 26 -
	- 27 -
MODBUS	- 28 -



CDJ1

CDJ1

CDJ1

17kW-500kW

CDJ1

1

DELIXI CDJ1系列电机软起动器	
产品标准	GB/T 14048.6-2016
产品型号	CDJ1-Z3-55kW
输入电压	50Hz AC380V
电机功率	55 kW
出厂编号	No.
德力西(杭州)变频器有限公司 生产日期 年 月	

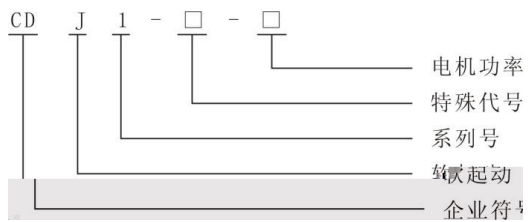

1

2

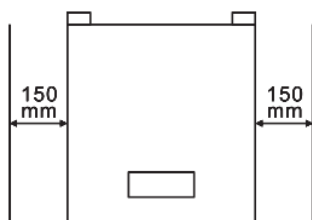

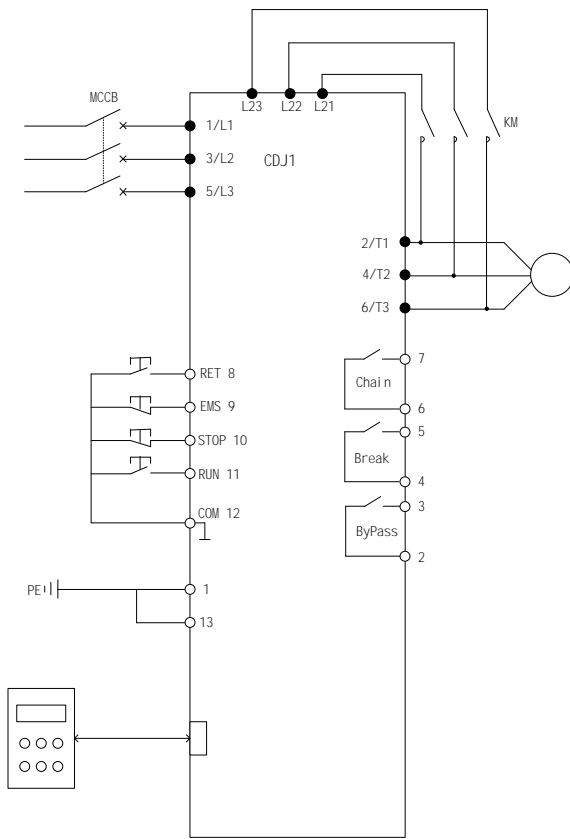

CDJ1

1.

1/L1 3/L2 5/L3		
2/T1 4/T2 6/T3		
L21 L22 L23		
E		

2.

	L21 L22 L23		

3.

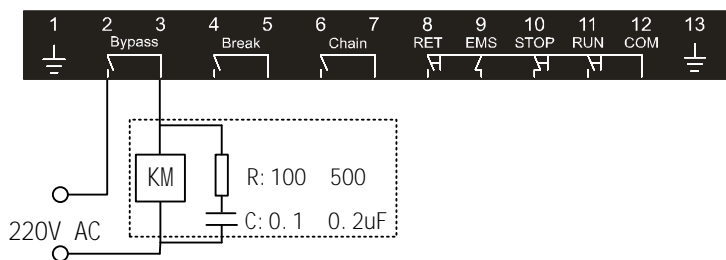

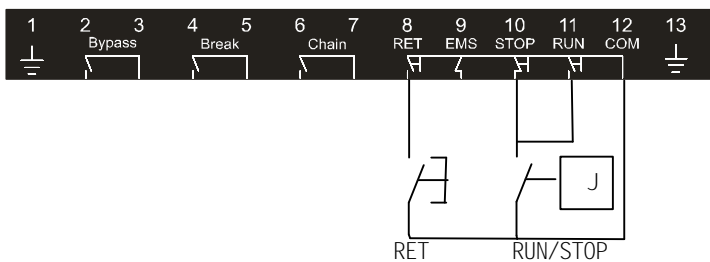
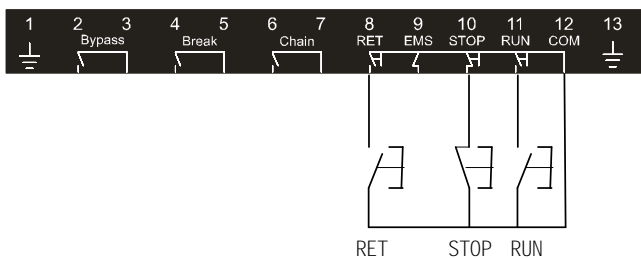

4.

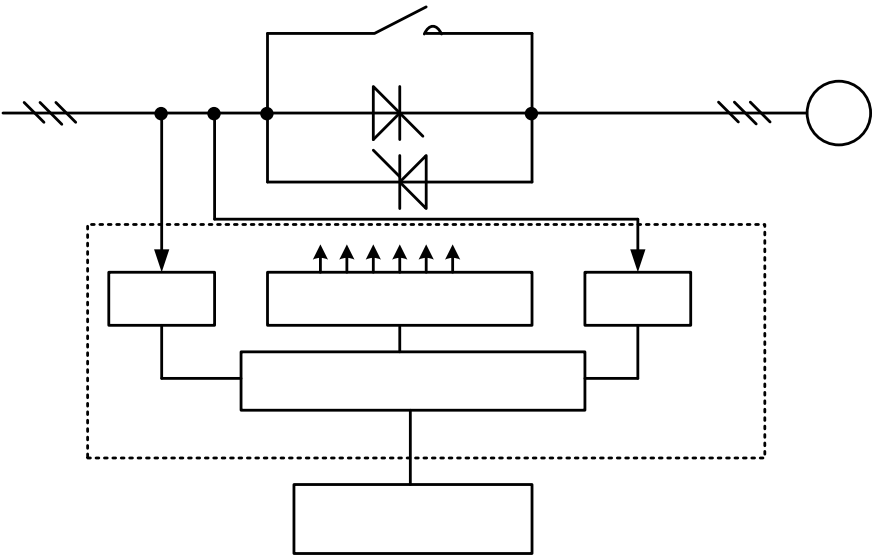

CDJ1

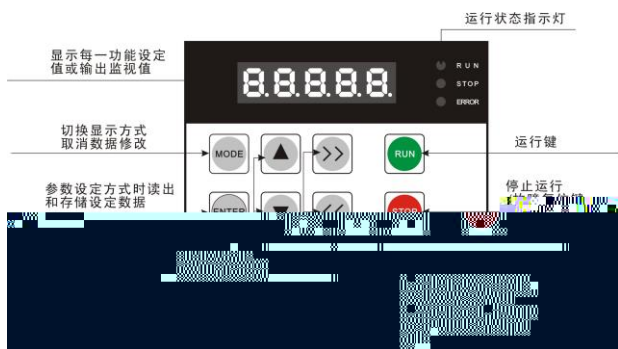

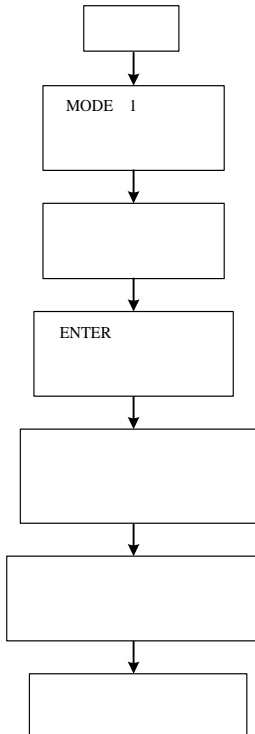

1	READY	MODE
2	P000	P000
3	P002	ENTER
4	02	02
5	05	05
6	P003	ENTER 05 P002 1 P003
7	P002	5 ENTER MODE 02 P002
8	READY	MODE

: P029

		0 2400bps 1 4800bps 2 9600bps 3 19200bps			
		0 ASCII N 8 1 () 1 ASCII E 8 1 () 2 ASCII O 8 1 () 3 RTU N 8 1 () 4 RTU E 8 1 () 5 RTU O 8 1 ()			

1 P000

P001

2 P002

0

n

3 P003

0

1

2

3

4

5



4 P004

5 P005

0 RUN, STOP
1 RUN/STOP/COM
2 + (3)

STOP-COM

3 PC

4 +PC

5 +PC RUN,STOP

6 + +PC

7 PC

6 P006

7 P007

P008

8 P009

P006

9 P010

10 P011

EMS

0

1

11 P012

(0) (1)

12 P013

P014

P015

P016

13 P017

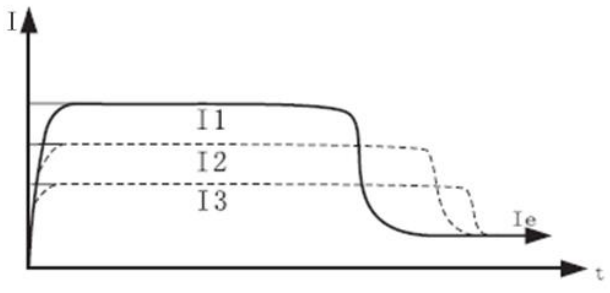

14 P018

P018=100% 150% 1 120%

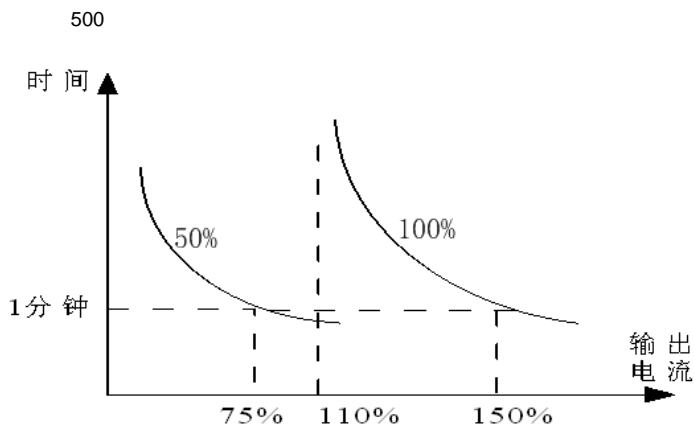

15 P019

0

1% 100%

K $K=I_s / I_d * 100\%$

I_s | I_a-I_b | I_a-I_c | I_b-I_c | I_d | I_a, I_b, I_c

16 P020

P021

FM GND

P021=0 4~20mA P021=1

0~20mA

20mA

P020

P020

17 P022

P023

P022=0

1

(P023)

2

P023

Ks

$Ks = I_s / I_e * 100\%$ (Ie

Is

)

18 P024

P024

P022

19 P025

P025

0

6

1

0

0

20 P026

P027

P028

21 P029

P029 1

0

22 P030

0

1

23 PASS

B CDJ1-S

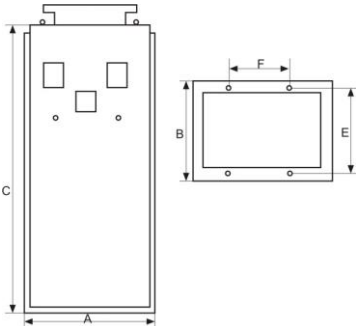

C CDJ1-S

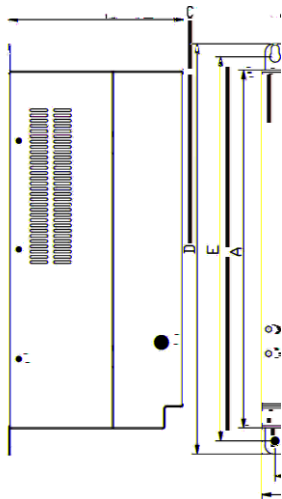
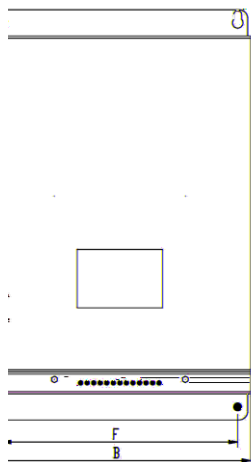

	kW	A							(kg)
			A	B	C	D	E	F	
CDJ1005S-CDJ1037S	5.5-37	10-69	350	250	180	410	380	220	11
CDJ1045S-CDJ1055S	45-55	90-110	410	300	200	470	440	270	17

③控制旁路接触器
 ④是无源继电器输出
 ⑤点新办急停输
 ⑥接点即为软件，接
 ⑦道为软起，12接
 ⑧共端；
 ⑨力接点为多功能继
 ⑩继电器点；
 ⑪启动器内置过流保
 ⑫载保护；
 ⑬点置位；
 ⑭/外接按钮操作
 ⑮定参 现用户手

⑯式限流型和电
 ⑰，任意自选；

德力西集团 有限公司	
列二次 线图	标准接线图

MODBUS

CDJ1

RS-485

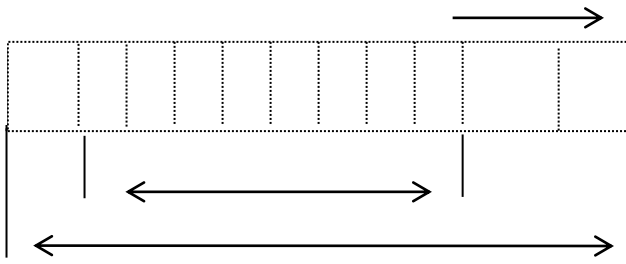

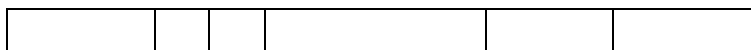

ASCII

ASCII

LRC Longitudinal Redundancy Check

LRC

A

256

LRC

LRC

